

Class II Microbiological safety cabinet

**BERNER FlowSafe®
B-[MaxPro]**



Made
in
Germany

Put your trust in a safe bench:

Maximum protection from infection
for your safety and well-being

BERNER
safety systems
made in Germany

Safety



Safe handling of biological substances.

BERNER INTERNATIONAL is your guarantor for complete safety when handling biological agents. We have been enhancing work and product safety for pharmaceutical and biotechnological applications since 1982.

We keep you safe at all times thanks to innovative „made in Germany“ solutions. We have gone to great lengths when developing our work safety equipment to ensure your maximum protection when working with biological agents which carry a high risk of infection.

Biological substances are divided into 4 risk groups based on their infectious, allergenic and toxic potential. Risk groups 1-4 correspond to protection and safety levels in laboratories. The class II microbiological safety cabinets **BERNER Flow-Safe® B-[MaxPro]** are the specially designed to provide maximum safety at protection levels 1-4.

Directive 2000/54/EC on the protection of workers, Directive 90/219/EEC on the contained use of genetically modified micro-organisms and DIN EN 12128 specify minimum requirements for biological safety in laboratories. When working with biological substances, a risk assessment should be carried out, and the required safety measures taken and adapted to the state of the art.

| Biological Substance Risk Group | Risk Potential | Prevention and Treatment | Protection and Safety Level | Safety Measure: MSC Class | Safety Function(s): MSC Class |
|---------------------------------|----------------|--------------------------|-----------------------------|----------------------------------|-------------------------------|
| 1 | Very low | Usually not necessary | S1 | Optional ^{a)} : I or II | I: Pe or II: Pe+Pr+Cr |
| 2 | Low | Possible | S2 | Optional: I or II | |
| 3 | High | Normally possible | S3 | Yes: I or II ^{b)} | II: Pe+Pr+Cr or III: Pe |
| 4 | Very high | Impossible | S4 | Yes: II ^{b)+c)} or III | |

^{a)}: Allergy prevention and/or product protection: class I/II MSC; ^{b)}: 3-filter-system recommended; ^{c)}: With externally ventilated protective suits pursuant to GenTSV [German Regulation on the Safety of Genetic Engineering]; MSC: microbiological safety cabinet; Pe: personal protection or containment capability at the working aperture; Pr: product protection; Cr: cross contamination protection

Of course it's good to have trust. But it's even better to have guarantees. This is why BERNER tests all aspects of the technical performance capabilities of the safety cabinets in a comprehensive PET (Performance Envelope Testing) procedure.

In this test different air currents were specifically loaded with bioaerosols. A nebulizer dispersed the bioaerosols from an apathogenic spore suspension of bacillus subtilis. In different sampling processes, data on contaminations, in the form of excessive bioaerosols that are output, are collected, incubated and analysed. With excellent results.

Perfect personal protection

So that biological substances do not pass the work access opening, we test the work protection equipment for their retaining capacity:

- Dispersion of 5 – 8 x 10⁸ CFUs (colony forming units) in 5 minutes.
- maximum of 10 CFUs in six fluid samplings and 5 CFUs in two channel samplers.
- 5 or 15 test cycles.



Microbiological testing of personal protection.

Totally reliable product protection

To ensure optimum manufacturing and experimental conditions, no contaminants are permitted to leave the environment and enter the workspace. For this reason our product protection equipment must pass the following tests:

- Dispersion of 5 – 8 x 10⁶ CFUs in 5 minutes.
- A maximum of 5 CFUs on all sedimentation culture plates.
- 3 test cycles.



Microbiological testing of product protection.

Maximum cross contamination protection

To prevent cross contamination, only an extremely limited number of bioaerosols may pass the workspace.

The following tests document the strict compliance with these settings:

- Dispersion of 5 – 8 x 10⁴ CFUs in 5 minutes.
- A maximum of 2 CFUs on all sedimentation culture plates.
- 6 test cycles.



Microbiological testing of cross contamination protection.

As the only manufacturer in Europe, BERNER INTERNATIONAL carries out microbiological test measures in its own laboratory in accordance with DIN EN 12469, DIN 12980 and NSF 49.



Ventilation

There are currently no longer any standardised velocity values for airflow when developing safety cabinets. The specific operating points of optimal safety functions rather depend on the particular model. And also on the individual manufacturer's standards.

This is a responsibility that we take very seriously. It is for that reason that you can find our philosophy right there in our name: BERNER – the safety system. Our research is centered on personal safety using the best protective functions. Therefore we activate the worst possible scenario – so that you never have to experience it.

In this test method, otherwise known as „**Performance Envelope Testing**“, contaminations are caused intentionally. By modifying the air movements in the front access opening and in the workspace, personal and product safety can no longer be assured above certain performance limits. Only by constantly exceeding the limits and enhancing our developments accordingly, it is possible for us to offer you unrivalled high safety standards with **BERNER FlowSafe®**.

Results of the microbiological test of personal and product protection based on air inflow and displacement flow.

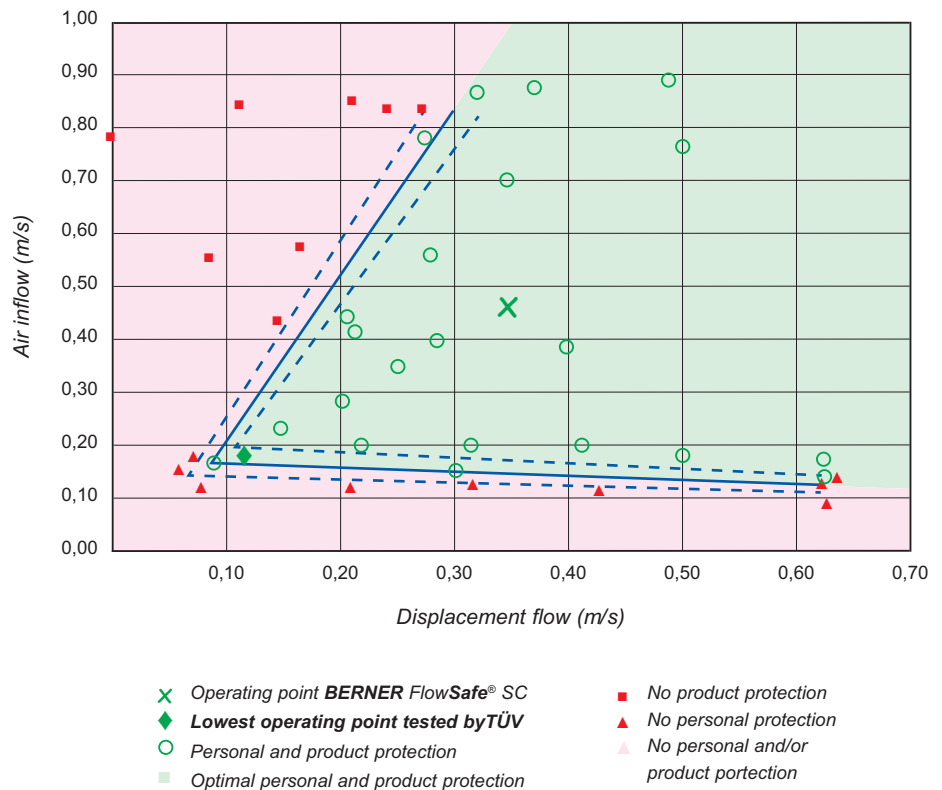

The result: The highest performance on the market

- The largest proven Performance Envelope.
- Flow dynamic defects are extremely well offset.
- Top level safety functions.
- Absolute safety even under extreme conditions.
- Fully microbiologically tested.
- Tested and accredited by the TÜV NORD CERT, Germany.



Comparison of Performance Envelope of different safety cabinets.

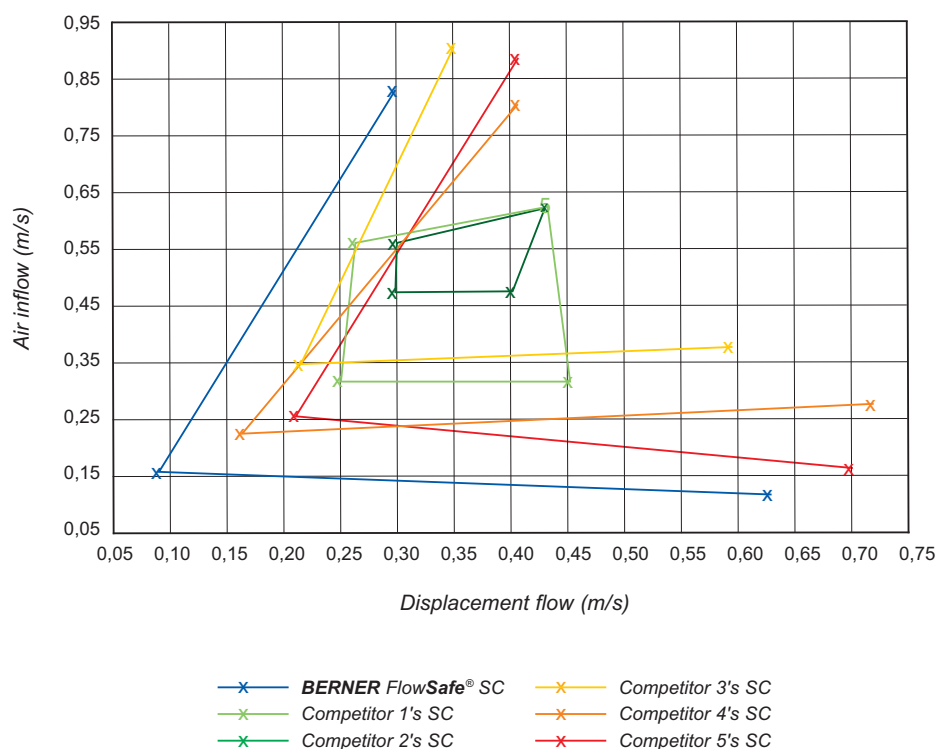

For your protection: Air movement only in controlled channels. For this reason the stable air barrier in the work access opening and an extreme laminar downflow (Uniform-DownFlow) in the working area ensure optimum capacity for personal, product and cross contamination protection.



Fast extraction of contaminations: Particles are cleared from the workspace after 2.3 seconds.

Intelligent solutions for innovative ventilation technology

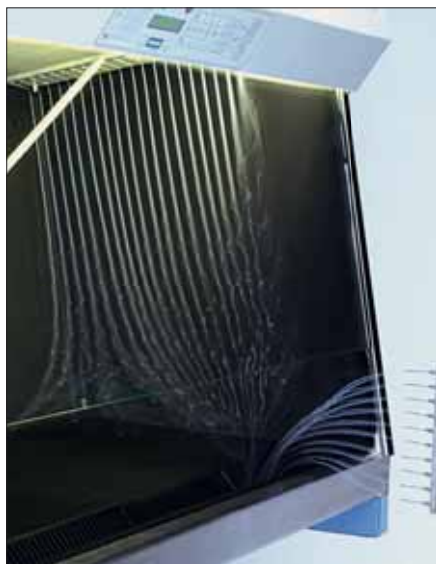

Powerful air flow for optimal protection..

- Digital safety control panel, **BERNER FlowSafe®** Control, monitors power supply, window position, flow conditions and filter status.
- Clear fault signalling via a display that includes detailed defect diagnostics.
- TA deep intake port on the front offers a high level of safety at any point around the work access opening, it also prevents cross contamination into the laboratory, stops from being blocked by the underarms and assures optimum air circulation.
- **Best-Pressure-Plenum** for even air distribution and fast particle transport.
- Ideal flow conditions due to an **Inflow-Downflow-Regulator**.
- **Block-Guard-Plus** the exhaust air ensures maximum personal protection.
- Sensor-controlled, electronic ventilator regulation to compensate filter loading.
- Excellent HEPA filter technology (High Efficiency Particulate Air) for maximum protection against contamination.
- 24 hour battery backed-up power failure alarm.
- Safety vacuum and gas-proof car case so that all contamination is certain to remain in the interior.
- Workspace that is compatible with good manufacturing practice:
 - High air exchange rate of approx. 1668/h.
 - Cleanroom class A resp. ISO class 5.
 - Fast clearance of contamination.
 - Perfect aseptic as well as particle-free manufacturing conditions.
 - Laminar downflow.
- Coarse particulate filter and intake protection device on clean-air side made from stainless steel to protect the filter against minute particles. *Only B-[MaxPro]



V shaped construction of the front intake port that ensures protection in the entire area of the work access opening.

Filters

When handling biological agents in high security laboratories you can never be too safe. That is why we play it really safe and equip the safety cabinets **BERNER Flow-Safe® B-[MaxPro]³** with a special filter technology: The 3-filter system.

As opposed to the commonly used 2-filter technology, the third filter level, through its **trend-setting filter layout**, offers not only a clearly higher level of safety, but also many other advantages:

- Redundant HEPA filter system.
- Very high total filtration efficiency of 99.9999975% in MPPS (Most Penetrating Particle Size).
- Protects better than ULPA filters (Ultra Low Penetration Air) of the U17 class.
- Main filter level directly beneath the work surface filters out particulate contamination via an extremely short air channel.
- No unnecessary contamination in inaccessible areas.
- Essential air conducting components such as filters, ventilators and air channels remain free of contamination.
- Complicated and costly filter changes and reductions, as required in a 2-filter system, can usually be foregone.
- Recirculation filters and exhaust air filters normally do not need to be changed.

Total degree of filtration of 2-filter systems vs. 3-filter systems.

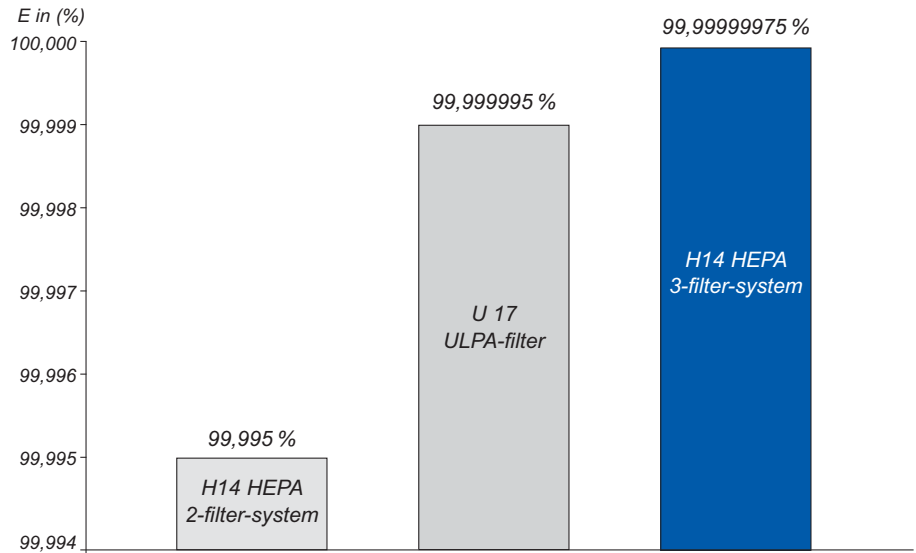

E: Integral total degree of filtration in MPPS.

Design, functional principle and contaminated areas of a safety cabinet with 2-and 3-filter systems.

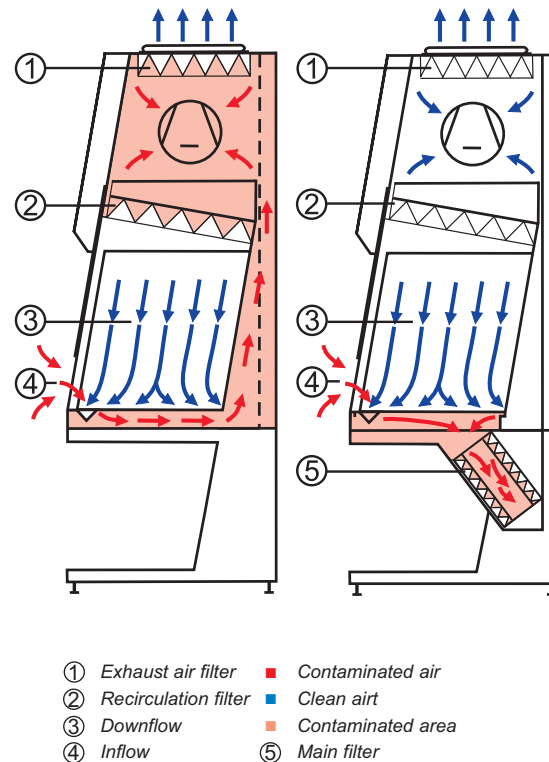

Good things come in three: The patented 3-filter system of the cytostatic safety cabinet **BERNER FlowSafe®** has treble the value for you.

1. Unique filter technology

- The HEPA cartridge filters Best-Filter-Protection provide you with the smallest main filter elements.
- Only half as many filter elements as with conventional wedge filter systems: 50% smaller replacement and test outlay – Reduction in follow-up costs.
- Protective grid on the clean air side ensures safe installation and removal.
- Long lasting performance capacity due to large effective filter area.
- Perfect air conduction through circular construction:
 - flow against the filter medium.
 - Low noise level.
- Flexible and continuous PU sealing for better seal seat.
- HEPA filter H14 in accordance with DIN EN 1822-1.



Unique cartridge filters: compact construction with twice the performance.

2. Optimum waste management

- The manageable shape of the cartridge filter facilitates safe and fast filter replacement.
- Used filters can be transported in virtually every customary waste disposal container.
- Low contamination filter change in accordance with DIN 12980.



Cartridge filters can be disposed of in normal waste disposal containers.

3. Perfect filter protection

- The utility model registered **Spill-Liquid-Guard** keeps blocked fluids away from the main filter.
- Protective grids prevent mechanical damage, e.g. when cleaning the work space.
- All filters have safety screens and safety guards.

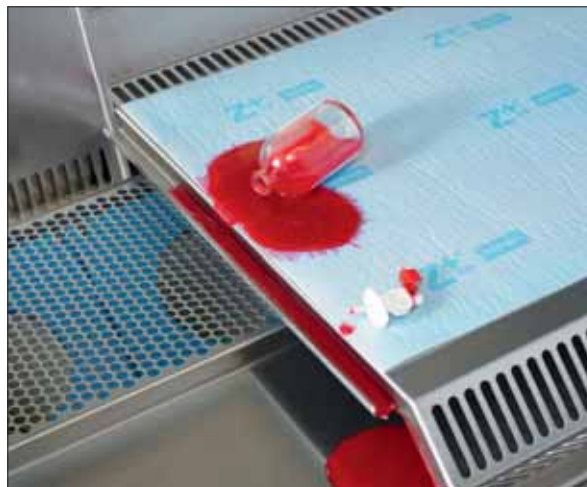

Main filter is protected against fluids and particles.

Ergonomics



Dynamic seating through flexible seating positions.



Arm support and work surface at the same height.

Whoever works in a laboratory, also cares a great deal about health when designing a work space. This is why we kept people uppermost when constructing the safety cabinets **BERNER FlowSafe®**. The guarantee for your sense of well being –

Ergonomic-Advantage-System.

Take a seat at your work space: The balanced, central seating position makes it possible for you to comfortably carry out your tasks without feeling tired. Preventive work protection for safe handling of biological substances.

- Dynamic seating in different positions – leaning forward, upright and leaning back – makes it comfortable to work and prevents postural injuries.
- You are seated close to the work and can easily reach all utensils in the work space.
- 10° tilted window rail allows more freedom of movement for the upper body.
- Arm support and work surface are aligned at the same height – this enables fine co-ordinated hand movement and comfortable movements at elbow level.
- No other comparable 3-filter system offers more legroom.



Maximum legroom thanks to the patented 3-filter system.

The **atmosphere** in the workplace is a decisive factor for unstressed but concentrated accurate work.

The optimal operating parameters as well as the functional design of the safety cabinet **BERNER FlowSafe®** combine to ensure the best conditions for the execution of laboratory tasks.

- Very quiet - up to a threshold of 51,3 dB(A).
- Bright reflection lighting of up to 1400 lx in the work space.
- Front panel unimpeded for by edge of glass to allow full view of the work space.
- Large side windows provide additional lighting.
- Low vibration of less than 5 µm on the stable work surface.



Operating elements within easy reach and displays within field of vision

Work was never so comfortable: Enjoy the user-friendly design of the safety cabinet and the well-arranged layout of the safety control panel **BERNER FlowSafe®** Control.

- All displays are located in your field of vision, making it much easier to control.
- All operating controls are within easy reach.
- User specific numerical codes are used to power on, power off and switch power sources.
- Illuminated display with date, time, operation timer and indicator of temperature and humidity in the work space.
- Timer to monitor important processes as well as test and production steps.
- Functional sockets in the work space.
- Elektrisch betriebene Frontscheibe.
- Normal, cleaning and night operation.
- Control board with RS 232 interface.

The ideal position for each individual

Ergonomics

Why should individuals have to adapt to their workplaces, if the workplace can adapt to the individual. Our engineers provided a solution to this question when they developed BERNER FlowSafe® safety cabinets.

The answer: **BERNER ErgoMove**.

A highly adjustable base frame complies with anthropometric requirements, that are currently applied to machine work places. It makes it possible to have flexibility between sitting and standing activity and thereby automatically avoids forced postures.

The work space can be customised for the individual based on the person's size and type of task - practically from the elbow height of the smallest person when seated person to the elbow height of the tallest person when standing.

The **adjustable work space** with **BERNER ErgoMove**:

- Work space height of 740 – 1110 mm = D 370 mm.
- Highest lift on the market for maximum flexibility.
- Stress-free seating position and comfortable standing positions are possible.
- Stable, safe and continuous electrically adjustable base frame.
- Tested and certified by the TÜV NORD CERT, Germany.

Seating and standing work place with adjustable work tops compared across safety cabinets.

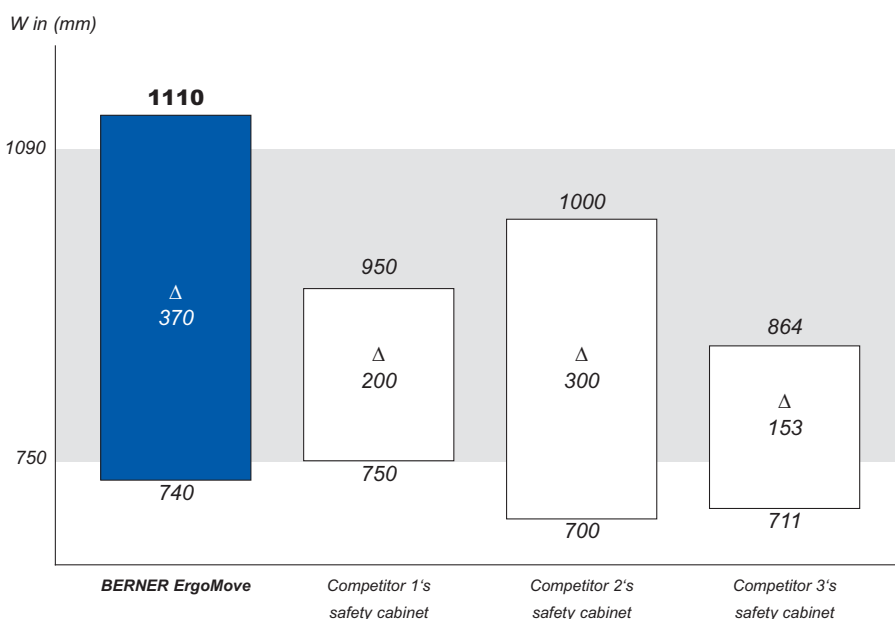

W: Height of work surface

■ Required adjustable area for the work surface height of safety cabinets in accordance with DIN EN ISO 14738



The highest performance even at the lowest heights.



Flexibility for taller operators is another attractive feature.



Pre- and post-processing of the individual safety test using the KI discus test.

The safety cabinet **BERNER FlowSafe® B-[MaxPro]** has not only found the right position for operation, but also for maintenance. All service work can be carried out easily from the front thanks to the intelligent design

In addition to the benefits of how it is constructed, the cabinet's technical configuration is also a winner. This provides double benefit for you: On the one hand you are economising thanks to reduced maintenance costs. On the other hand, the accessible components facilitate the efficient setting of all parameters using service software for perfect safety and operating conditions.

- Very precise adjustability of the flow conditions.
- Faster and safer filter replacement.
- Connections for filter inspection as well as all components downstream the main filter in the clean area.
- Electrical components are also located on a service panel.

It's important for you to know that you can totally depend on **BERNER**. This applies to our safety cabinets in the same way as it applies to our employees. The outstanding quality of our people and our products has been repeatedly confirmed by TÜV.

From type testing to the training of our individually certified service technicians, our independent, regular tests fully comply with the German Equipment and Product Safety Act (GPSG).

Unsere Checkliste für geprüfte Sicherheit auf dem aktuellsten Stand

- DIN EN 12469 (09.2000) ✓
- DIN 12980* (06.2005) ✓

* Only B-[MaxPro]³



Testing of the HEPA recirculation filter.

BERNER
safety systems
made in Germany

The many benefits of electronic data processing

EDP

Software for hard facts: **BERNER** offers you a special program for the display, monitoring and archiving of all data – monitoring software **BERNER FlowSafe®** for the [MaxPro]-130 and -190 models.

- Colour coded status of the safety cabinet (off, operating modes, no connection).
- Comment function for error messages.
- Individual user administration for up to 10 people.
- Statistic function differentiated according to operation modes (min., max., median values, alarm messages):
 - Air inflow and downflow.
 - Temperature.
 - Air humidity.
 - Window position.
- Specific alarm, limit and measurement values.
- Sensor corrective factors for air inflow and downflow.
- Network capability: Up to 25 safety cabinets.
- Specific information: Model, year of manufacture, serial and inventory number, location, authorised users, etc.

Vernetzung erlaubt die bequeme externe Überwachung mittels Datentransfer.

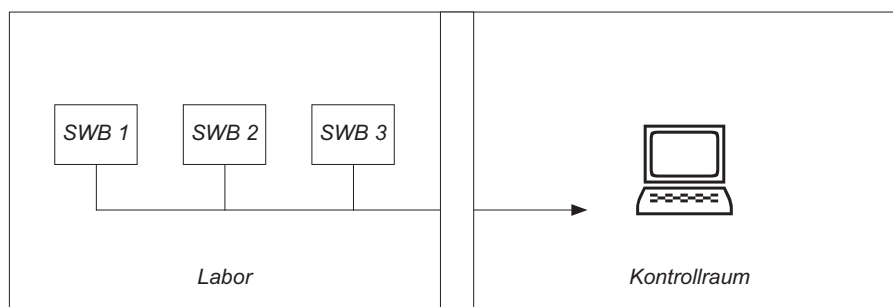

- Service: Documentation of work carried out, service due reminder function.
- Display of:
 - Flow velocity (Inflow and Downflow).
 - Filter status.
 - Fault diagnostics and detailed error logs.
 - Operating times safety cabinet and UV-C sterilisation system.
 - Consumers used etc.
- Export of all data displayed for statistical analysis in Microsoft® Excel or Microsoft® Access.
- Complete documentation of the entire production process in the safety cabinet.

Clear overview of the measurement values in the form of tables and diagrams.

BERNER is the **only manufacturer** of safety cabinets who offers additional **monitoring software** to display, check and archive important data.



Leaving everything ready for the next day's work. **BERNER FlowSafe®** safety cabinet offers you additional features to make it easy to quickly clean and disinfect daily.

- Segmented panels in the work space – can be easily raised, repositioned and decontaminated:
 - Cleaning in the workspace prevents cross contamination.
 - Sterilisation in many autoclaves is possible.
 - Greatly increases the work safety in comparison with continuous, heavy work tops..
 - 1.5 mm thick „V2A“ stainless steel – robust, durable and extremely stable.
- Interior has low number of welded connections and large, integrated surfaces.
- The front window can be opened up to a width of 550mm – ease of cleaning



Cleaning: Simply safe.

- for all areas.
- Optimal UV-C sterilisation system **Quick-Decon:**
 - Securely installed above the work space.
 - Fast disinfection due to high capacity up to 220 $\mu\text{W}/\text{cm}^2$.
 - Shadowless illumination.
 - Higher degree of sterilisation efficiency.

Type tested and certified 3-filter system with **segmented work tops**.



Efficient **inactivation** – that you can rely on!

To take an active part in the state of the art technology **BERNER** regularly carries out research and development projects in cooperation with independent institutes. Amongst others, the effective inactivation of **BERNER** safety cabinets and cartridge filters has been examined and confirmed. Research for your safety!

- Inactivation of **BERNER FlowSafe®** safety cabinets using H_2O_2 fumigation.
 - In accordance with DIN EN 12469 Appendix J
 - H_2O_2 as an alternative to formaldehyde:
 - Fast method.
 - High biological effectiveness.
 - Good penetration capacity.
 - Residue-free.
 - Design validated as state of the art.
 - Comprehensively tested using biological and chemical indicators.



H_2O_2 fumigation of a **BERNER FlowSafe®** safety cabinet with the SKANAIR® DECOSIS system

- Inactivation of HEPA filter cartridges **Best-Filter-Protection** using autoclaving.
 - Can be carried out on-site.
 - Lower costs.
 - Comprehensively tested using biological indicators.



Autoclaving of a HEPA filter cartridge **Best-Filter-Protection**.

BERNER
safety systems
made in Germany

You can order other optimisations

Options

GMP compliant documentation and testing

- Individual qualification in accordance with EU GMP Guidelines Appendix 15.
- Design Qualification, Installation Qualification, Operational Qualification, Site Acceptance Test and Factory Acceptance Test.
- Currently tested and certified in an exemplary fashion by TÜV SÜD Clean-cert.



Laminar downflow

- Maintenance of the laminarity is proven by validated processes.
- External monitoring of the flow speed within the safety cabinet through additional sensor.

Continuous particle monitoring

- Monitoring of the particle cleanroom class A in the work area.
- Integration of a secure or mobile isokinetic sampling probe.

Stainless steel finish for high demand activities

An option with multiple beneficial features:

- High resistance to disinfectants.
- Robust, durable, high value in terms of design and make.

Segmented HEPA-recirculation filter.

- Perfect for S3 and S4 laboratories.
- Every filter 610 x 610 x 90 mm.
- Type-tested and certified by the TÜV Nord Cert.
- Inactivated by autoclaving.
- No laborious filter disposal.
- Operating permit quickly and easily obtained.

Safe extraction of exhaust air

The **GMP cover** for connection of the safety cabinet, without backflow, to the exhaust air unit, also serves to ventilate laboratories. Additional benefit: A minimum of surfaces requiring cleaning is achieved as a result of the three-sided GMP compliant covering above the safety cabinet.



Safety cabinet in stainless steel finish for high demand laboratories.



Segmented HEPA recirculation filter.

Activation of the monitoring and air ventilation systems (RTL facilities)

Potential-free contacts enable an external monitoring or ventilation system to be activated, which make it possible to provide an accurate operational status for on, normal operation, night mode or alarm signals.

Connection to Integral Clean Room Monitoring System (GRM)

To enhance your safety, we also expand on the strengths of others. So that you can integrate all the important safety cabinet data of your laboratory network in a GRM system (integral clean room monitoring system), we have aligned ourselves with Briem®. An effective co-operation leading to efficiency in compatibility.

No two safety cabinets produced by BERNER are the same. That is due to the fact that you can equip your safety cabinet according to your personal suggestions and individual needs. You have the choice:

| Item No. | Description | Standard | Option | Page |
|-------------------|---|----------|--------|------|
| – | General details | | | |
| – | Two function sockets, 230 VAC, 50 Hz | • | | 9 |
| – | Power failure alarm | • | | 5 |
| – | Temperature and humidity display in the work area | • | | 9 |
| – | Timer | • | | 9 |
| – | Night mode | • | | 9 |
| 01 01 10 7002 | RS-232 Interface Datalink ¹⁾ | | • | |
| 01 01 20 7001 | Function socket 230VAC, 50Hz (additional) | | • | 9 |
| 01 01 10 7036 | Dimmable inner lighting optionally with radio button or remote control, - 130 | | • | |
| 01 01 10 7136 | Dimmable inner lighting optionally with radio button or remote control, - 190 | | • | |
| – | 4 side window panel openings, d=22 mm | • | | |
| 01 01 10 7029 | Waste disposal unit, (right side) ²⁾ | | • | |
| 01 01 10 7030 | Waste disposal unit, (left side) ²⁾ | | • | |
| 01 01 10 7034 | Protective covering for cable connection | | • | |
| 02 0098 | On-site assembly in laboratories that are difficult to access, -130 | | • | |
| 02 0099 | On-site assembly in laboratories that are difficult to access, -190 | | • | |
| | EDP work station | | | |
| 01 01 20 70 02/04 | Monitor window ErgoView for 20" monitor, B-[MaxPro] ^{2/3)} | | • | |
| 01 01 10 7015 | Flat screen holder ³⁾ ScreenBase plus , -130 ⁴⁾ | | • | |
| 01 01 10 7115 | Flat screen holder ³⁾ ScreenBase plus , -190 ⁵⁾ | | • | |
| 01 01 10 7043 | 19" Flat screen monitor (4:3), integrated | | • | |
| 01 01 10 7048 | 22" Flat screen monitor (16:10), integrated | | • | |
| 01 01 10 7010 | Interface adapter RS 232 / LocalCan | | • | |
| 01 01 10 7006 | PC holder Tower-Base | | • | |
| 01 4202 | Printer shelf | | • | |
| 01 01 10 7023 | Swivel-mounted keyboard shelf | | • | |
| 01 01 10 8901 | Weighing work top Low-Vibrations-System – original equipment | | • | |
| 01 01 10 8902 | Weighing work top Low-Vibrations-System – extra equipment | | • | |
| | Base unit | | | |
| 01 01 20 7015 | Seated work space, height: 765 mm (±20) ⁶⁾ , -130 | | • | |
| 01 01 20 7017 | Seated work space, height: 765 mm (±20) ⁶⁾ , -190 | | • | |
| 01 01 20 70 16 | Standing work space, height: 1063 mm (±20), B-[MaxPro] ²⁻ 130 | | • | |
| 01 01 10 70 19 | Standing work space, height: 1063 mm (±20), B-[MaxPro] ³⁻ 130 | | • | |
| 01 01 20 70 18 | Standing work space, height: 1063 mm (±20), B-[MaxPro] ²⁻ 190 | | • | |
| 01 01 10 70 20 | Standing work space, height: 1063 mm (±20), B-[MaxPro] ³⁻ 190 | | • | |
| 01 01 20 70 19 | Elect. height adjust. BERNER ErgoMove 740-1110 mm (±5), B-[MaxPro] ²⁻ 130 ⁷⁾ | • | 10 | |
| 01 01 10 70 21 | Elect. height adjust. BERNER ErgoMove 740-1110 mm (±5), B-[MaxPro] ³⁻ 130 ⁷⁾ | | | |
| 01 01 20 70 20 | Elect. height adjust. BERNER ErgoMove 740-1110 mm (±5), B-[MaxPro] ²⁻ 190 ⁷⁾ | | • | 10 |
| 01 01 10 70 22 | Elect. height adjust. BERNER ErgoMove 740-1110 mm (±5), B-[MaxPro] ³⁻ 190 ⁷⁾ | | | |
| | Exhaust air system | | | |
| 06 1635 | GMP-Cover ⁸⁾ , -130 | | • | 14 |
| 06 1009 | GMP-Cover ⁸⁾ , -190 | | • | 14 |
| 01 01 20 7008 | Potential-free contact, normal mode | | • | 14 |
| 01 01 20 7007 | Potential-free contact, night mode | | • | 14 |
| 01 01 10 7003 | Potential-free contact, combined alarm | | • | 14 |
| | Cleanroom | | | |
| 01 01 10 7004 | Connection to an external monitoring system ⁹⁾ | | • | 14 |
| 01 01 10 7033 | Outlet for external flow monitoring | | • | 14 |
| 01 01 10 7041 | Air flow visualisation | | • | 14 |
| 01 01 10 7016 | Fitting for the connection of a fixed or mobile isokinetic sampling probe | | • | 14 |
| 01 01 10 7045 | Integration of a mobile isokinetic sampling probe | | • | 14 |
| 01 01 10 7046 | Integration of a fixed isokinetic sampling probe in the rear wall | | • | 14 |
| 01 4400 | Kalibrierzertifikat für Strömungssonde | | • | |
| 01 01 10 7035 | Calibration certificate for the flow sensor | | • | |
| 01 01 10 7100 | Monitoring Software BERNER FlowSafe® Monitoring – basic licence | | • | 12 |
| 01 01 10 7137 | Monitoring Software BERNER FlowSafe® Monitoring – extended licence | | • | 12 |
| 01 01 10 7042 | GMP documentation in accordance with EU GMP Guidelines Appendix 15 ¹⁰⁾ | | • | 14 |
| | Biotechnological applications | | | |
| 01 01 20 7021 | Lab equipment –gas ¹¹⁾ | | • | |
| 01 01 20 7012 | UV-C sterilisation QuickDecon , -130 | | • | 13 |
| 01 01 20 7112 | UV-C sterilisation QuickDecon , -190 | | • | 13 |
| 01 01 20 7004 | Segmented recirculation filter, -130 | | • | 14 |
| 01 01 20 7010 | Segmented recirculation filter, -190 | | • | 14 |
| ¹²⁾ | Stainless steel finish, -130, -190 | | • | 14 |

1) Additional interfaces (such as RS232, USB, PS2, RJ45, etc.) are available.

2) Item numbers for side panel of the waste disposal device on request.

3) Suitable for virtually all available standard flat screen monitors on the market with "VESA FMPPM 75/100 standard"

4-5) In the laboratory, there must be a minimum of 4) 340 mm and 5) 492 mm available to the right and left of the safety cabinet.

6) Standard for B-[MaxPro]³.

7) Use currently only in recirculated-air operation.

8) For a closed cover this available up to a maximum height of 3 metres.

9) clean room monitoring system (GRM) from Briem®.

10) Individual consultation and quote, based on requirements.

11) Additional laboratory instruments available.

12) Item number on request.

Class II Microbiological Safety Cabinet BERNER FlowSafe® B-[MaxPro]

| General Data | | | | |
|---|---|------------------------------|---|------------------------------|
| Product group | BERNER FlowSafe® | | | |
| Device | Laboratory device | | | |
| Device type | Class II microbiological safety cabinet | | | |
| Construction type | DIN EN 12469; DIN 12980; NSF 49 | | | |
| Certificate | TÜV GS certificate | | | |
| Labelling | CE | | | |
| Production | DIN EN ISO 9001:2000 | | | |
| Model | B-[MaxPro] ² -130 | B-[MaxPro] ³ -130 | B-[MaxPro] ² -190 | B-[MaxPro] ³ -190 |
| Item number | 01 01 30 0130 | 01 01 20 013001 01 30 0190 | 01 01 20 0190 | |
| General Technical Data | | | | |
| Sound pressure level pursuant to ISO 11201 | ≥ 51,3 dB(A) | ≥ 56,6 dB(A) | ≥ 53,4 dB(A) | ≥ 57,6 dB(A) |
| Nominal illuminance | ≤ 1200 lx | | ≤ 1400 lx | |
| Work area material | 1,5 mm thick stainless steel, material number: 1.4301 | | | |
| Casing material | 1,5 mm thick, powder-coated Zincor sheet steel, material number: 1.0131 | | | |
| Front, side and rear panel window | Multi-layer safety glass | | | |
| Electrical Data | | | | |
| Rated voltage and frequency | 230 V AC; 50 Hz | | | |
| Rated current ^{a)} / rated power | 9,4 A bzw. 2162 VA | 8,0 A bzw. 1840 VA | 12,5 A bzw. 2875 VA | 9,4 A bzw. 2162 VA |
| Protection class | I | | | |
| Typical protection | IP 20 | | | |
| Connection | Three-pin plug | | | |
| <small>a): The total rated current decreases by up to 5 A when not using the sockets in the work area. The total load on the sockets must not exceed 5 A!</small> | | | | |
| Mechanical Data: Width / Height / Depth [mm] | | | | |
| Overall dimension ^{b)} seated workstation | 1340 / 2215 ± 20 / 875 | | 1945 / 2215 ± 20 / 875 | |
| Weight ^{c)} | 1340 / 1532 / 875 or 800 (without rear panel) | | 1945 / 1532 / 875 or 800 (without rear panel) | |
| Gewicht | approx. 296 kg | approx. 327 kg | approx. 400 kg | approx. 444 kg |
| <small>b): The upper part of the device, base frame, main filter box (only B-[MaxPro]² + filters are set up and installed on-site! c): Allow an extra 10 mm both horizontally and vertically! The smallest installation dimensions (e.g. door, staircase, etc.) must be co-ordinated prior to delivery. Device height: take the pallet into account!</small> | | | | |
| Ventilation Data | | | | |
| Volumetric flow rate of downflow air | approx. 947 m ³ /h | | approx. 1403 m ³ /h | |
| Volumetric flow rate of exhaust/inflow air | approx. 357 m ³ /h | | approx. 541 m ³ /h | |
| AER Normal in the work area | approx. 1668/h | | | |
| AER Night in the work area | approx. 715/h | | | |
| Thermal load | 7005 kJ/h | 5962 kJ/h | 9315 kJ/h | 7005 kJ/h |
| Main, recirculation air + exhaust air filters | HEPA filters, class ≥ H 14 in accordance with DIN EN 1822-1 Integral degree of filtration: E ≥ 99,995% in MPPS | | | |
| Preliminary coarse dust filter | • | - | • | - |
| Filter system (number of HEPA filters) | 2-filter system | 3-filter system | 2-filter system | 3-filter system |
| Redundant HEPA filtration | - | • | - | • |
| Low-contamination filter change | - | • | - | • |
| Number of BFP main cartridge filters | - | 6 | - | 9 |
| Clean room class in the work area | ECG GMP Guide: A; DIN EN ISO 14644-1: 5 US Federal Standard 209E:M 3,5 / 100; VDI 2083 Blatt 1: 3 | | | |

BERNER INTERNATIONAL GmbH owns the copyright for the contents of this brochure. Subject to technical changes.
Several illustrations contain optional extras and features not supplied as standard.

Operating principle and dimensions [mm]

Front view:

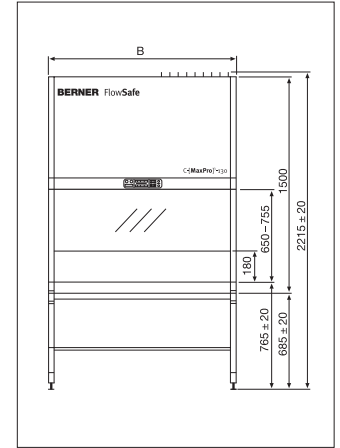

Side view:

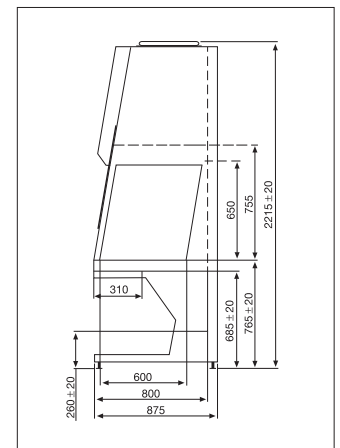

BERNER – certified safe

Proven high quality and safety through independent sample testing, certification and regular checks based on the German Equipment and Product Safety Act (GPSG).



BERNER INTERNATIONAL GMBH
Mühlenkamp 6 · D-25337 Elmshorn
Tel.: +49 / (0) 41 21 / 43 56-0
Fax: +49 / (0) 41 21 / 43 56-20
info@berner-international.de
www.berner-international.eu

